



**LEDS BRIGHT LIGHTING TECHNOLOGY CO., LIMITED**



(Facebook)

Add: NO.22, Xinmao Industrial Zone, Henglan Zhongshan City, Guangdong, 528478, China  
Tel: 0086-760 8761 5412      Mobile: 0086-13968795482  
Email: [eric.sales1@elightoe.com](mailto:eric.sales1@elightoe.com)      [www.girasoled.com](http://www.girasoled.com)  
Twitter: @ledsbright  
Youtube: @ledsbrightlightingcoltd.4873

**SOLAR LIGHTS**

**LEDS BRIGHT LIGHTING TECHNOLOGY CO., LIMITED**  
No.22, Xinmao Industrial Zone, Henglan Zhongshan City, Guangdong, 528478, China

2024  
V-1.0



- ▶ MONTHLY NEW PRODUCT LAUNCH
- ▶ MARKET PROTECTION POLICY
- ▶ AVOID HOMOGENEOUS COMPETITION



 <b>PRODUCTION</b> <b>300.000pcs</b> Monthly production capacity <b>6</b> Production lines <b>10000+</b> Square meters area <b>150+</b> Employees	 <b>R&amp;D</b> <b>12</b> People of R&D team <b>13yrs'</b> Experiences in led product	 <b>QUALITY</b> QC in charge of <b>6</b> production lines <b>3</b> Times quality inspection during production of each order	 <b>QUALITY</b> <b>10</b> Salesmen <b>5yrs</b> Average working age <b>15</b> Days for mass order
---	--	--	--

## About us

GIRASOLED is a new brand founded by LEDS BRIGHT LIGHTING TECHNOLOGY CO., LIMITED (also known as Zhongshan Tongxi Lighting Technology Co., Ltd.) in Zhongshan, China. GIRASOLED focuses on high quality solar lights which include ultra bright solar floodlight, solar street light, solar UFO pole light, solar garden light and solar wall light etc.

LEDS BRIGHT LIGHTING TECHNOLOGY CO., LIMITED is a professional manufacturer and supplier on LED and solar lighting products since 2009. Its product category covers the commercial, industrial and residential fields. The items are in hot sale and have been widely exported to Europe, North and South America, Australia and Asia etc.

As a high-tech enterprise, LEDS BRIGHT has been approved by international quality system ISO9001-2000, and its products are FCC, CE, RoHs, CCC approved. With the 10+ years' development, the company is specialized in R&D, production, sourcing and marketing. LEDS BRIGHT company owns 2 factories with production capacity of 300,000 pcs lights per month. The professional R&D team launches new products monthly to help customers develop new markets. As a reliable long-term supplier, it provides market protection policies for customers of different business types to avoid homogeneous competition.

LEDS BRIGHT LIGHTING TECHNOLOGY CO., LIMITED has become a premium supplier of global industry brands. Looking forward to working with you, to be partners, to be friends.

SOLAR FLOOD LIGHT SERIES	EL-JBP SERIES	EL-JLFX SERIES	EL-JBP SERIES	EL-JBP SERIES
SOLAR STREET LIGHT SERIES	EL-CJ SERIES	EL-YT4 SERIES	EL-YYC SERIES	EL-YH SERIES
SOLAR GARDEN LIGHT SERIES	EL-UFO SERIES	EL-YX SERIES	EL-LX SERIES	
SOLAR WALL LIGHT SERIES	EL-SWL SERIES	EL-SXQ SERIES	EL-EWF SERIES	
SOLAR LED STRIP LIGHT SERIES	EL-DD SERIES			
SOLAR POST/LAWN LIGHT SERIES	EL-QW SERIES	EL-ZTD SERIES	EL-CPD SERIES	EL-FY SERIES



# SOLAR FLOOD LIGHT EL-JBP SERIES



- Remote control and light control
- Charging time effective sunshine 4-6 hours
- Working hours last for 2 cloudy days

## UNIQUE APPEARANCE DESIGN

Private Mould, More Competitive.

Material:ABS+Glass  
Auto Mode Max.Working Time:14H  
Charging Time:4-6H

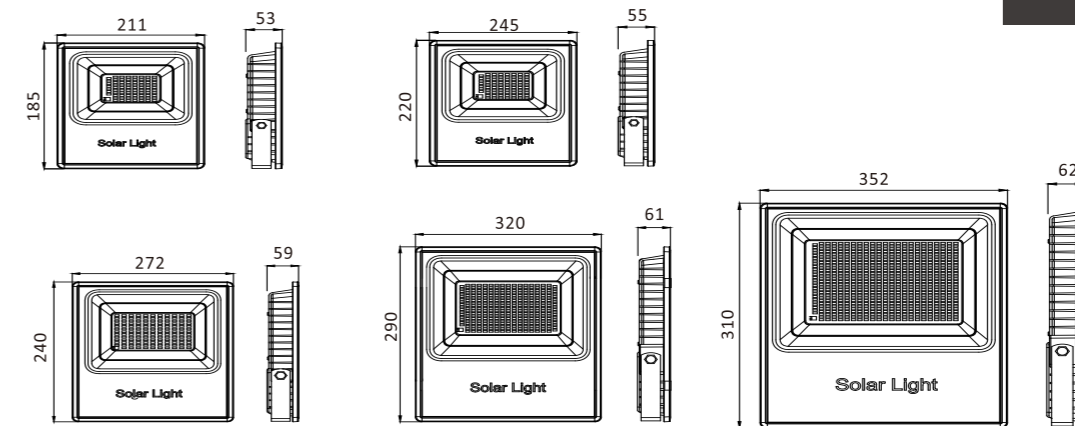
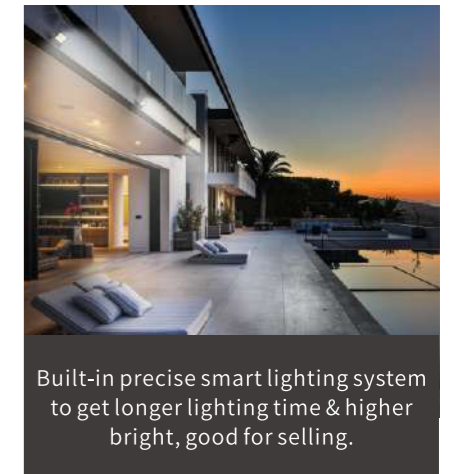

Model NO.	LED Source Power	Lumen	Solar Panel	Battery	Chips & QTY	Lamp Body Size (L * W * H)	Solar Panel Size
EL-JBP-100	100W	400lm	6W/6V	4AH	5730/56PCS	211*185*53mm	180*270*15mm
EL-JBP-200	200W	600lm	8W/6V	5AH	5730/92PCS	245*220*55mm	235*350*15mm
EL-JBP-300	300W	800lm	15W/6V	12AH	5730/132PCS	272*240*59mm	350*350*15mm
EL-JBP-400	400W	1200lm	20W/6V	16AH	5730/196PCS	320*290*61mm	350*450*15mm
EL-JBP-500	500W	1600lm	25W/6V	20AH	5730/416PCS	352*310*62mm	350*530*17mm



# SOLAR FLOOD LIGHT EL-JLFX SERIES

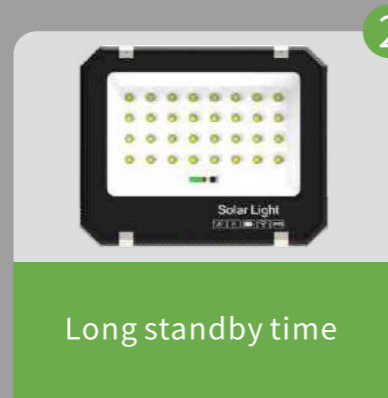
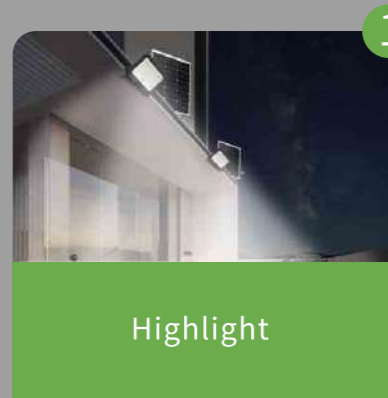

- Remote control and light control
- Charging time effective sunshine 4-6 hours
- Working hours last for 2 cloudy days

**UNIQUE APPEARANCE DESIGN**  
Private Mould, More Competitive.

Material:ABS+Glass  
Auto Mode Max.Working Time:14H  
Charging Time:4-6H



205\*170\*44.5mm



255.6\*210.6\*44.5mm



305.6\*256.6\*46.5mm



360.5\*300.5\*46.5mm

Model NO.	Lumen	Solar Panel	Battery	Chips & QTY	Power Cord	Lamp Body Size	Solar Panel Size
EL-JLFX-050W	600lm	6W/5V	5AH 3.2V	5050/18PCS	0.3mm <sup>2</sup> /2Meters	205*170*44.5mm	210*200*17mm Monocrystal
EL-JLFX-100W	1200lm	10W/5V	10AH 3.2V	5050/32PCS	0.5mm <sup>2</sup> /2Meters	255.6*210.6*44.5mm	205*300*17mm Monocrystal
EL-JLFX-150W	1800lm	15W/5V	15AH 3.2V	5050/45PCS	0.5mm <sup>2</sup> /2Meters	305.6*256.6*46.5mm	390*230*17mm Monocrystal
EL-JLFX-200W	2200lm	20W/5V	20AH 3.2V	5050/66PCS	0.5mm <sup>2</sup> /2Meters	360.5*300.5*46.5mm	390*300*17mm Monocrystal
EL-JLFX-450W	3200lm	30W/5V	30AH 3.2V	5050/66PCS	0.75mm <sup>2</sup> /2Meters	360.5*300.5*46.5mm	390*430*17mm Monocrystal





# SOLAR FLOOD LIGHT EL-JLTJ SERIES

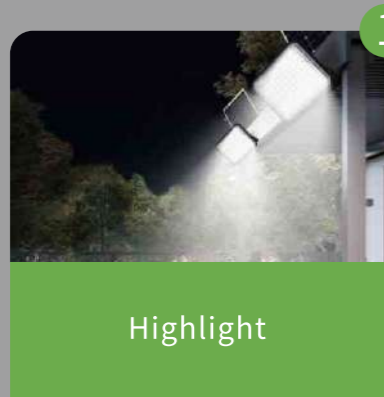

- Remote control and light control
- Charging time effective sunshine 4-6 hours
- Working hours last for 2 cloudy days

**UNIQUE APPEARANCE DESIGN**  
Private Mould, More Competitive.

Material:ABS+PC  
Auto Mode Max.Working Time:14H  
Charging Time:4-6H



205\*170\*44.5mm



255.6\*210.6\*44.5mm



305.6\*256.6\*46.5mm



360.5\*300.5\*46.5mm

Model NO.	Lumen	Solar Panel	Battery	Chips & QTY	Power Cord	Lamp Body Size	Solar Panel Size
EL-JLTJ-050W	700lm	6W/5V	5AH 3.2V	3030/21PCS	0.3mm <sup>2</sup> /2Meters	205*170*44.5mm	210*200*17mm Monocrystal
EL-JLTJ-100W	1400lm	10W/5V	10AH 3.2V	3030/45PCS	0.5mm <sup>2</sup> /2Meters	255.6*210.6*44.5mm	205*300*17mm Monocrystal
EL-JLTJ-150W	2000lm	15W/5V	15AH 3.2V	3030/66PCS	0.5mm <sup>2</sup> /2Meters	305.6*256.6*46.5mm	390*230*17mm Monocrystal
EL-JLTJ-200W	2700lm	20W/5V	20AH 3.2V	3030/91PCS	0.5mm <sup>2</sup> /2Meters	360.5*300.5*46.5mm	390*300*17mm Monocrystal
EL-JLTJ-450W	4100lm	30W/5V	30AH 3.2V	3030/91PCS	0.75mm <sup>2</sup> /2Meters	360.5*300.5*46.5mm	390*430*17mm Monocrystal



# SOLAR FLOOD LIGHT EL-JLYX SERIES



Highlight



Long standby time



- Remote control and light control
- Charging time effective sunshine 4-6 hours
- Working hours last for 2 cloudy days

**UNIQUE APPEARANCE DESIGN**  
Private Mould, More Competitive.

Material:ABS+Glass  
Auto Mode Max.Working Time:14H  
Charging Time:4-6H



Intelligent adjustment in rainy days



Quick heat dissipation



205\*170\*44.5mm



255.6\*210.6\*44.5mm



305.6\*256.6\*46.5mm



360.5\*300.5\*46.5mm

Model NO.	Lumen	Solar Panel	Battery	Chips & QTY	Power Cord	Lamp Body Size	Solar Panel Size
EL-JLYX-050W	600lm	6W/5V	5AH 3.2V	2835/90PCS	0.3mm <sup>2</sup> /2Meters	205*170*44.5mm	210*200*17mm Monocrystal
EL-JLYX-100W	1200lm	10W/5V	10AH 3.2V	2835/174PCS	0.5mm <sup>2</sup> /2Meters	255.6*210.6*44.5mm	205*300*17mm Monocrystal
EL-JLYX-150W	1800lm	15W/5V	15AH 3.2V	2835/282PCS	0.5mm <sup>2</sup> /2Meters	305.6*256.6*46.5mm	390*230*17mm Monocrystal
EL-JLYX-200W	2200lm	20W/5V	20AH 3.2V	2835/554PCS	0.5mm <sup>2</sup> /2Meters	360.5*300.5*46.5mm	390*300*17mm Monocrystal
EL-JLYX-450W	3200lm	30W/5V	30AH 3.2V	2835/554PCS	0.75mm <sup>2</sup> /2Meters	360.5*300.5*46.5mm	390*430*17mm Monocrystal





# SOLAR FLOOD LIGHT EL-RYTJ SERIES

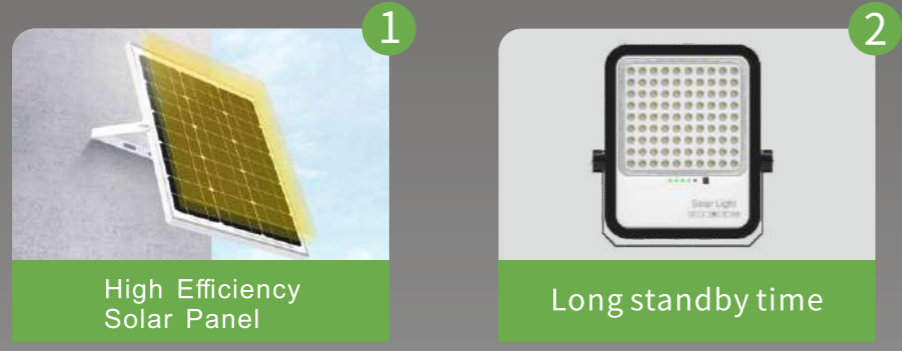

- Remote control and light control
- Charging time effective sunshine 4-6 hours
- Working hours last for 2 cloudy days

**UNIQUE APPEARANCE DESIGN**  
Private Mould, More Competitive.

Material:ABS+Glass  
Auto Mode Max.Working Time:14H  
Charging Time:4-6H

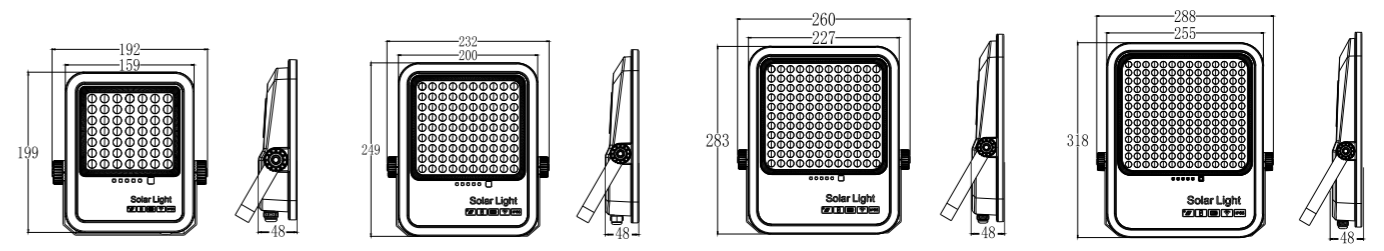

Model NO.	LED Source Power	Lumen	Solar Panel	Battery	Chips & QTY	Lamp Body Size (L * W * H)	Solar Panel Size
EL-RYTJ-050W	50W	600lm	6W/5V	4AH	2835/49PCS	198*193*48mm	210*200*17mm
EL-RYTJ-100W	100W	1200lm	10W/5V	8AH	2835/49PCS	198*193*48mm	205*300*17mm
EL-RYTJ-150W	150W	1800lm	15W/5V	12AH	2835/90PCS	248.5*233*48mm	390*230*17mm
EL-RYTJ-200W	200W	2400lm	18W/5V	16AH	2835/90PCS	248.5*233*48mm	390*280*17mm
EL-RYTJ-250W	250W	3000lm	20W/5V	20AH	2835/132PCS	283*260*48mm	390*300*17mm
EL-RYTJ-300W	300W	3600lm	25W/5V	25AH	2835/132PCS	283*260*48mm	390*360*17mm
EL-RYTJ-350W	350W	4200lm	30W/5V	28AH	2835/182PCS	318*288*48mm	390*430*17mm
EL-RYTJ-400W	400W	4800lm	35W/5V	32AH	2835/182PCS	318*288*48mm	390*510*17mm



# SOLAR FLOOD LIGHT EL-YY SERIES



**ALUMINUM Shell**

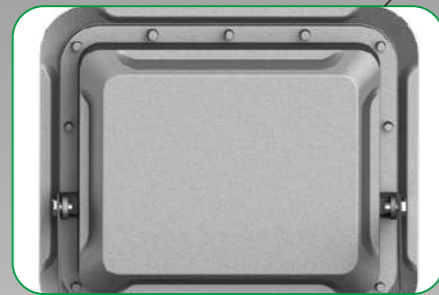

Die-casting Aluminum Shell

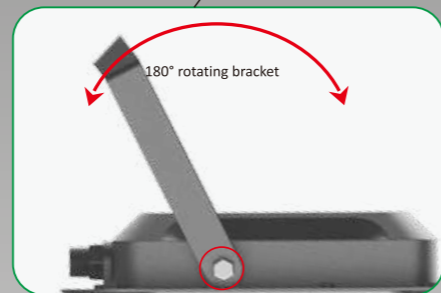

Aluminum Bracket, anti-corrosion, rustproof, 180° flexible adjustment

- Remote control and light control
- Charging time effective sunshine 4-6 hours
- Working hours last for 2 cloudy days

**UNIQUE APPEARANCE DESIGN**  
Private Mould, More Competitive.

Material: Aluminum+PC  
Auto Mode Max.Working Time:14H  
Charging Time:4-6H

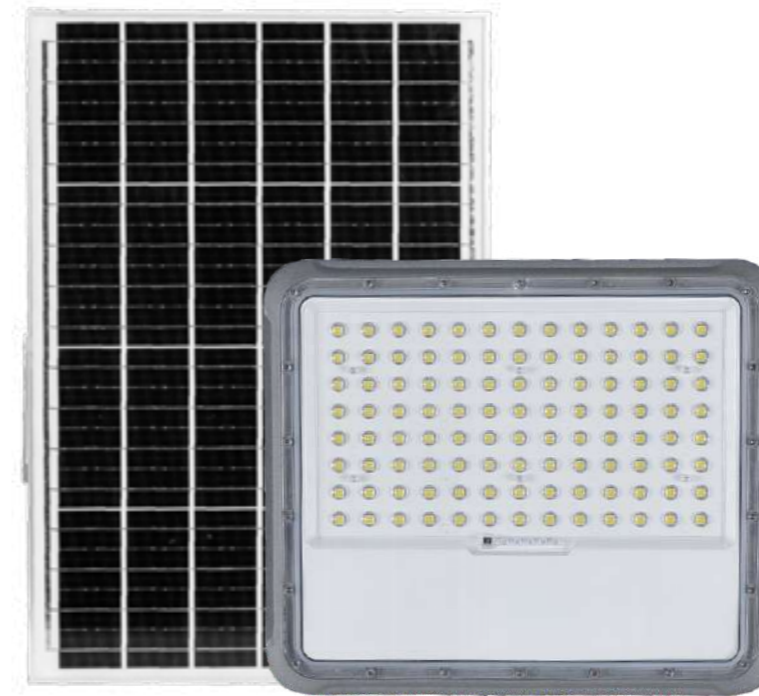

Intelligent adjustment in rainy days



Die-casting Aluminum Shell  
Quick heat dissipation

A variety of lenses are available

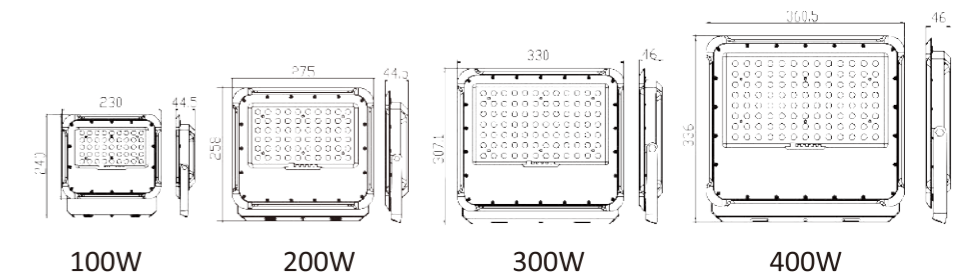
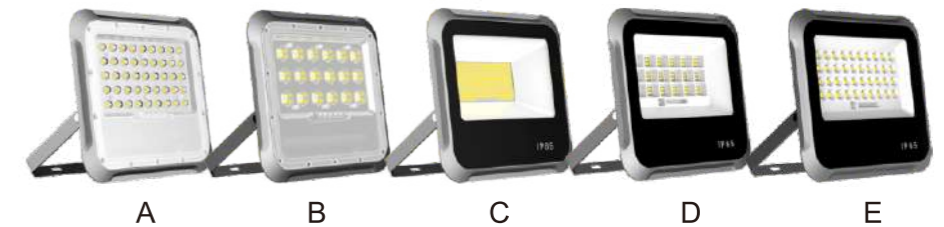

Model NO.	LED Source Power	Lumen	Solar Panel	Battery	Chips & QTY	Lamp Body Size (L * W * H)	Solar Panel Size
EL-YY-100	100W	900lm	15W/6V	12AH	5050/45PCS	230*240*44mm	350*350*15mm
EL-YY-200	200W	1500lm	20W/6V	18AH	5050/60PCS	275*258*45mm	350*450*15mm
EL-YY-300	300W	2000lm	25W/6V	20AH	5050/84PCS	330*307*46mm	350*530*17mm
EL-YY-400	400W	3500lm	35W/6V	30AH	5050/104PCS	360*336*46mm	390*560*17mm





# PORTABLE WORK LIGHT EL-GZD SERIES

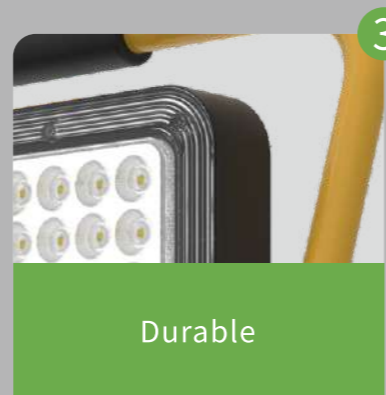
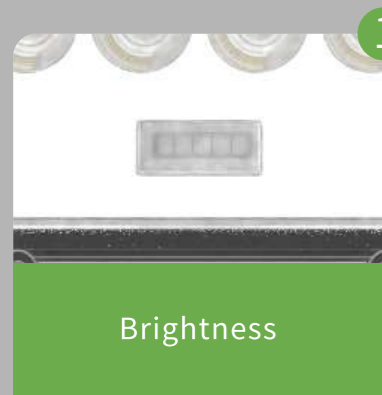

- Remote control and light control
- Charging time effective sunshine 5-6 hours
- Working hours last for 2 cloudy days

## SUITABLE FOR MANY OCCASIONS

Suitable For Stall Setting At Night, Site Construction, Vehicle Repair And Camping Outdoor Sports, Dinner At Night, Emergency Warning Lights, Etc

Material:ABS+PC  
Max. Working Time:16H @low light  
Charging Time:5-6H @ 5V 2A



Standard accessories

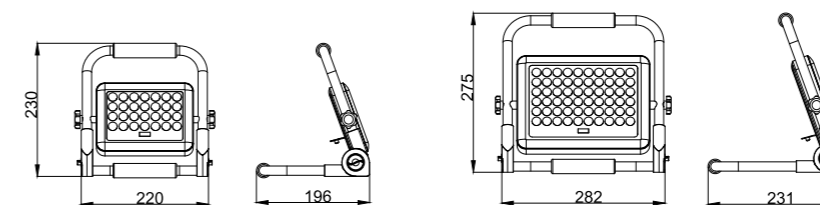

Super high brightness compare with others, built-in precise smart lighting system, good for selling.



Collapsible



Solar panel for option

Model NO.	LED Source Power	Lumen	Solar Panel	Battery	Chips & QTY	Lamp Body Size	Solar Panel Size
EL-GZD-40	40W	500lm	Option	4AH	3030/28PCS	230*220*196*238*56mm	/
EL-GZD-60	60W	800lm	Option	6AH	3030/28PCS	230*220*196*238*56mm	/
EL-GZD-100	100W	1200lm	Option	10AH	3030/60PCS	275*282*231*285*58mm	/
EL-GZD-150	150W	2000lm	Option	15AH	3030/60PCS	275*282*231*285*58mm	/





Material:ABS+PC

Max. Working Time:6-8H

Charging Time:8H

PRODUCT FEATURES

- Brightness
- Certified 3.2V LiFePO4 battery, longer lifespan, no problem for shipping.

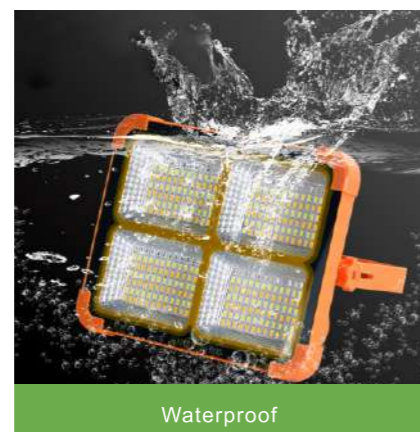

Model NO.	Color Temp.	Lumen	Solar Panel	Battery	Chips & QTY	Lamp Body Size	Solar Panel Size
EL-SXQ-6	3000K/6500K/RGB OPTION	840lm	2W/5V	1800mAH	3030/6PCS RGB 5050/6pcs	155*100*40mm	150*94mm



Material:ABS+PC

Auto Mode Max. Working Time:14H

Charging Time:4-6H

PRODUCT FEATURES

- Brightness
- Convenient installation (5m cable+)
- Certified 3.2V LiFePO4 battery, longer lifespan, no problem for shipping.

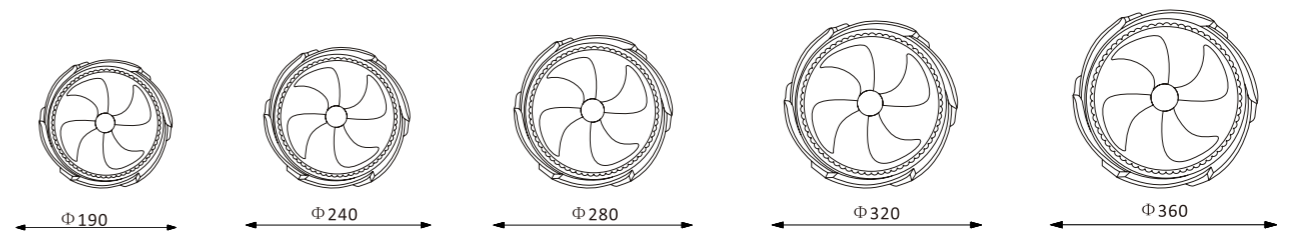

Model NO.	LED Source Power	Lumen	Solar Panel	Battery	Chips & QTY	Lamp Body Size	Solar Panel Size
EL-XD-100	100W	400lm	4W/6V	3AH	2835/72PCS	Φ190*70mm	135*235*13mm
EL-XD-200	200W	600lm	8W/6V	5AH	2835/132PCS	Φ240*70mm	270*180*16mm
EL-XD-300	300W	800lm	10W/6V	6AH	2835/260PCS	Φ280*70mm	235*350*16mm
EL-XD-400	400W	1800lm	15W/6V	12AH	2835/388PCS	Φ320*70mm	350*350*17mm
EL-XD-500	500W	2400lm	22W/6V	20AH	2835/428PCS	Φ360*70mm	350*450*17mm





# INTEGRATED SOLAR STREET LIGHT EL-CJ SERIES

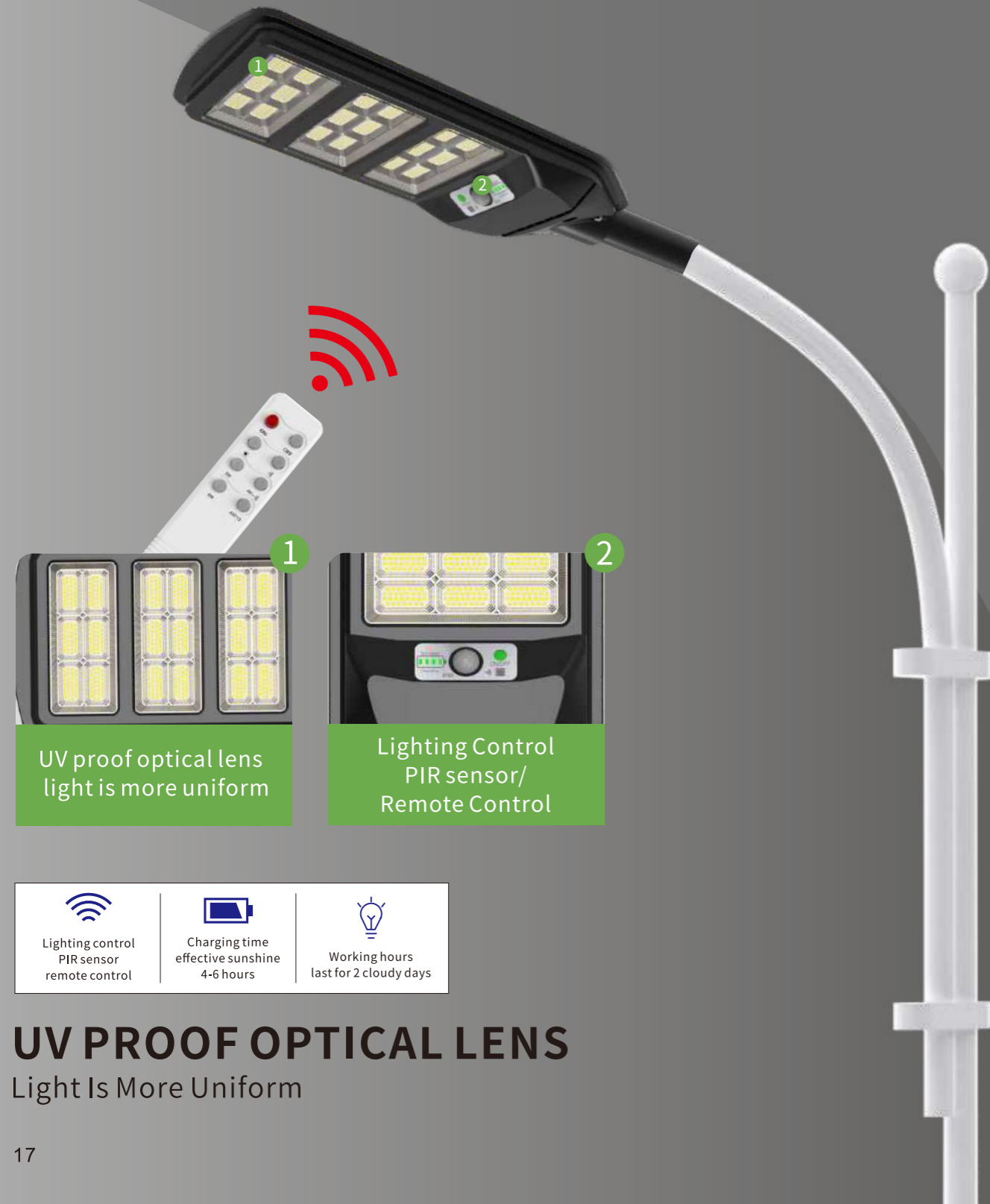

1  
UV proof optical lens  
light is more uniform

2  
Lighting Control  
PIR sensor/  
Remote Control

Lighting control PIR sensor remote control	Charging time effective sunshine 4-6 hours	Working hours last for 2 cloudy days
--	--	---

**UV PROOF OPTICAL LENS**  
Light Is More Uniform

Material:ABS+Lens  
Auto Mode Max. Working Time:14H  
Charging Time:4-6H



A Type



LiFePo4 battery  
Large-capacity lithium iron  
phosphate battery, long life



B Type



Intelligent Adjustment In Rainy Days

- Highlight
- ABS+PS
- PIR Sensor
- High Efficiency Solar Panel

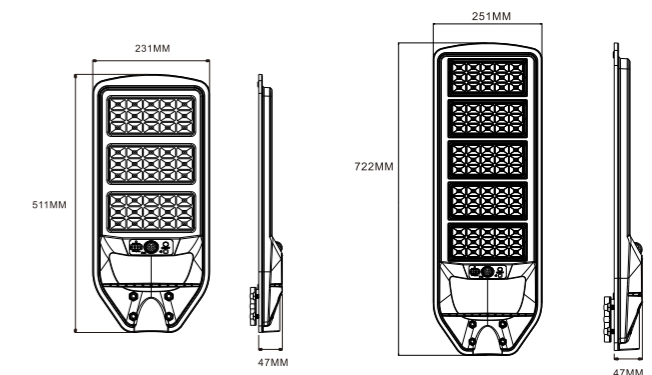

Model NO.	LED Source Power	Lumen	Solar Panel	Battery	Chips & QTY	Lamp Body Size	Solar Panel Size
EL-CJ-100W A/B	100W	700lm	10W/5V	8AH	5054-56PCS	413*231*47mm	299*211*4mm
EL-CJ-150W A/B	150W	1400lm	12W/5V	12AH	5054-84PCS	511*231*47mm	397*211*4mm
EL-CJ-200W A/B	200W	2100lm	15W/5V	15AH	5054-112PCS	622*251*47mm	508*231*4mm
EL-CJ-250W A/B	250W	2800lm	20W/5V	20AH	5054-140PCS	722*251*47mm	608*231*4mm





# INTEGRATED SOLAR STREET LIGHT EL-YT2 SERIES



UV proof clear PC cover  
Bright light output



Lighting Control  
PIR sensor/  
Remote Control

<p>Lighting control PIR sensor remote control</p>	<p>Charging time effective sunshine 4-6 hours</p>	<p>Working hours last for 2 cloudy days</p>
---	---	---

## UV PROOF CLEAR PC COVER

Bright light output

Material:ABS+PC  
Auto Mode Max. Working Time:14H  
Charging Time:4-6H



**LiFePo4 battery**  
Large-capacity lithium iron phosphate battery, long life



Built-in precise smart lighting system to get longer lighting time & higher bright, good for selling.

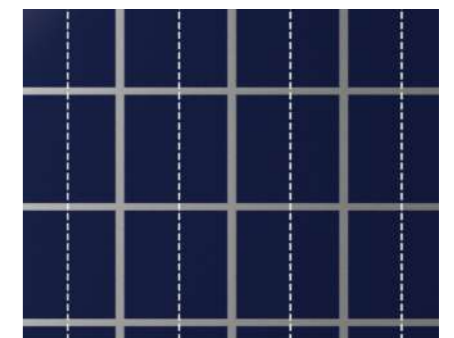

High efficiency poly crystal solar panel, smaller size and save CBMs.

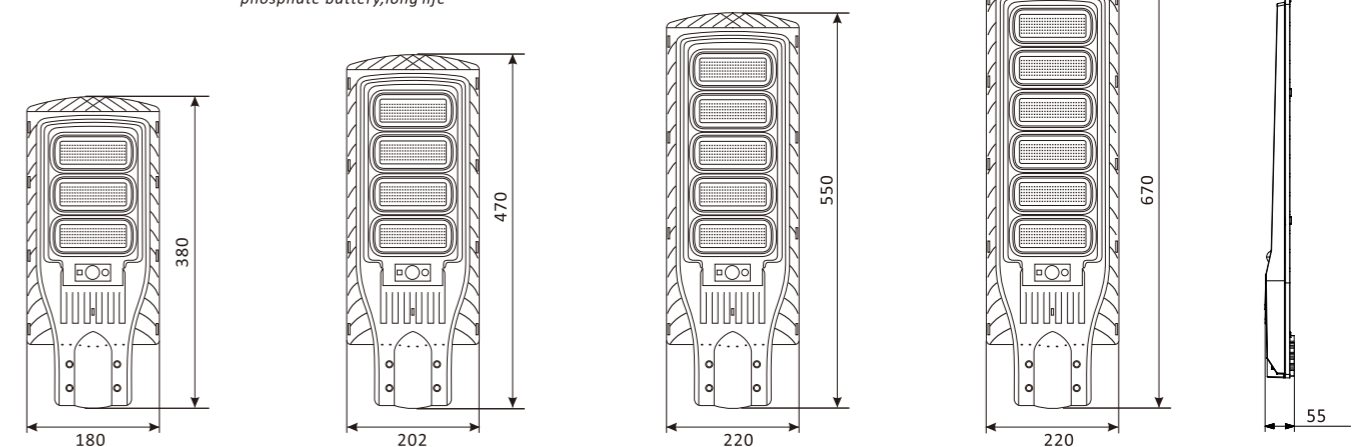

Model NO.	LED Source Power	Lumen	Solar Panel	Battery	Chips & QTY	Lamp Body Size	Solar Panel Size
EL-YT2-150	150W	600lm	6W/6V	5AH	2835/40PCS*3	380*180*55mm	172*291mm
EL-YT2-200	200W	1200lm	10W/6V	9AH	2835/40PCS*4	470*202*55mm	194*383mm
EL-YT2-250	250W	1800lm	14W/6V	13AH	2835/40PCS*5	550*220*55mm	208*498mm
EL-YT2-300	300W	2400lm	18W/6V	16.5AH	2835/40PCS*6	670*220*55mm	208*578mm
EL-YT2-350	350W	3000lm	22W/6V	20AH	2835/40PCS*7	790*220*58mm	210*663mm



# INTEGRATED SOLAR STREET LIGHT EL-YT4 SERIES

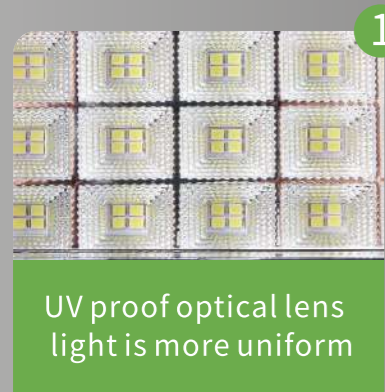
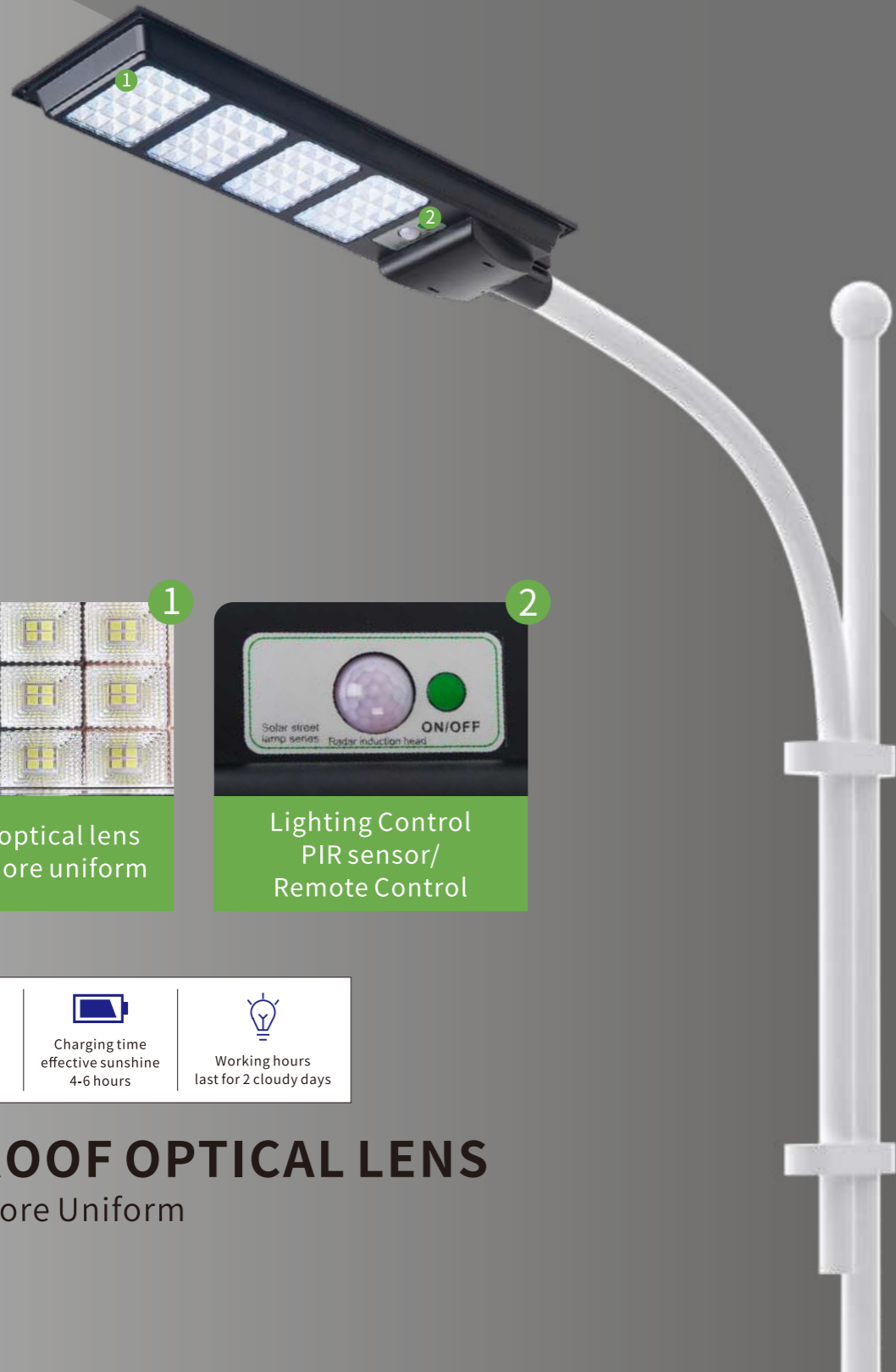

UV proof optical lens  
light is more uniform



Lighting Control  
PIR sensor/  
Remote Control

<p>Lighting control PIR sensor remote control</p>	<p>Charging time effective sunshine 4-6 hours</p>	<p>Working hours last for 2 cloudy days</p>
---	---	---

**UV PROOF OPTICAL LENS**  
Light Is More Uniform

Material:ABS+Lens  
Auto Mode Max. Working Time:14H  
Charging Time:4-6H



LiFePo4 battery  
Large-capacity lithium iron  
phosphate battery, long life



Built-in precise smart lighting system  
to get longer lighting time & higher  
bright, good for selling.

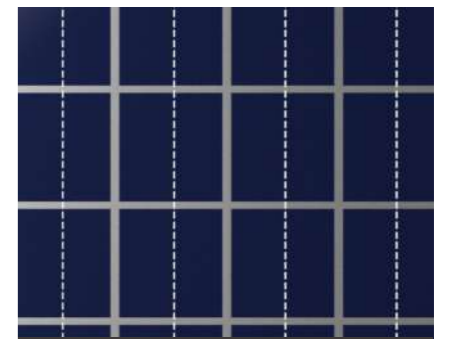

High efficiency poly crystal solar  
panel, smaller size and save CBMs.

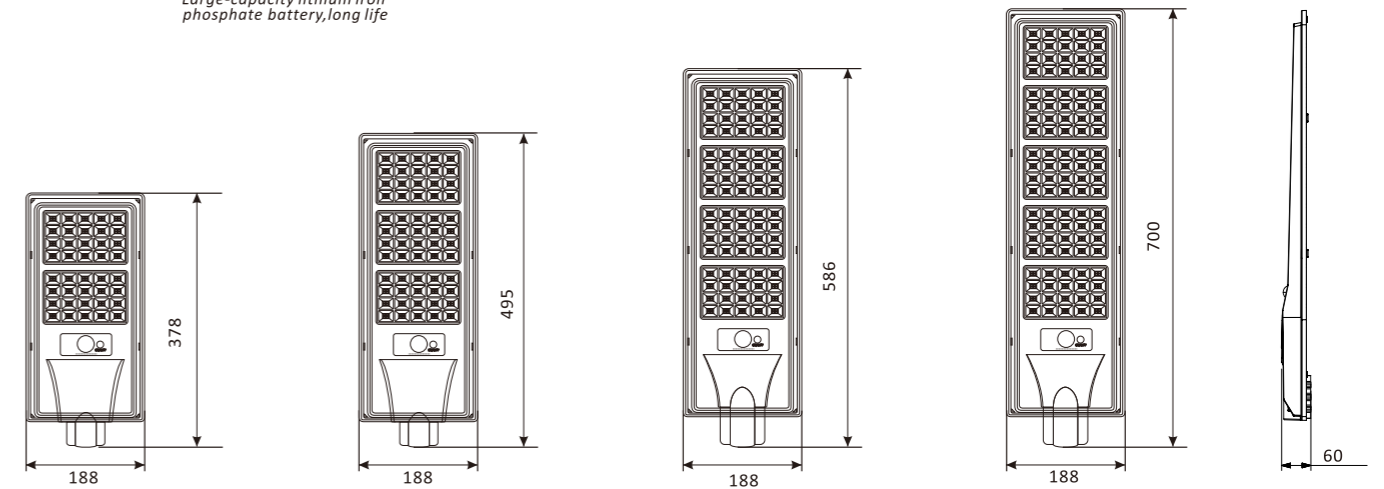

Model NO.	LED Source Power	Lumen	Solar Panel	Battery	Chips & QTY	Lamp Body Size	Solar Panel Size
EL-YT4-100	100W	600lm	6W/6V	5AH	2835/80PCS*2	378*188*60mm	171*336mm
EL-YT4-150	150W	1200lm	10W/6V	9AH	2835/80PCS*3	495*188*60mm	171*456mm
EL-YT4-200	200W	1800lm	14W/6V	13AH	2835/80PCS*4	586*188*60mm	171*547mm
EL-YT4-250	250W	2400lm	18W/6V	16.5AH	2835/80PCS*5	700*188*60mm	171*638mm





# SEPARATED SOLAR STREET LIGHT EL-YYC SERIES

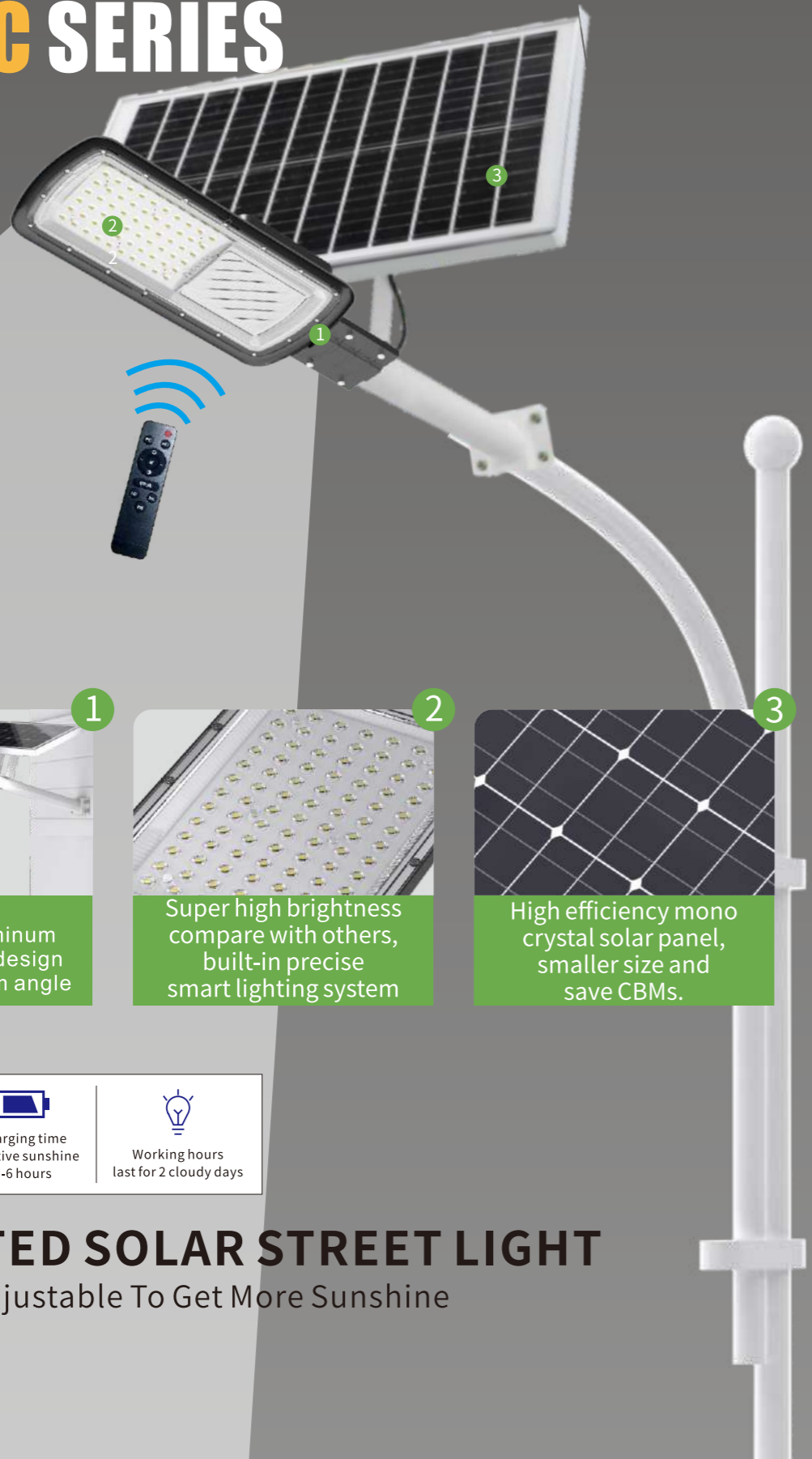

1  
Die-casting Aluminum Shell, ultra slim design 120 degree beam angle

2  
Super high brightness compare with others, built-in precise smart lighting system

3  
High efficiency mono crystal solar panel, smaller size and save CBMs.

- Remote control and light control
- Charging time effective sunshine 4-6 hours
- Working hours last for 2 cloudy days

## SEPARATED SOLAR STREET LIGHT Solar Panel Adjustable To Get More Sunshine

Material:Die-casting Aluminum+PC lens  
Auto Mode Max. Working Time:14H  
Charging Time:4-6H



LiFePo4 battery  
Large-capacity lithium iron phosphate battery, long life

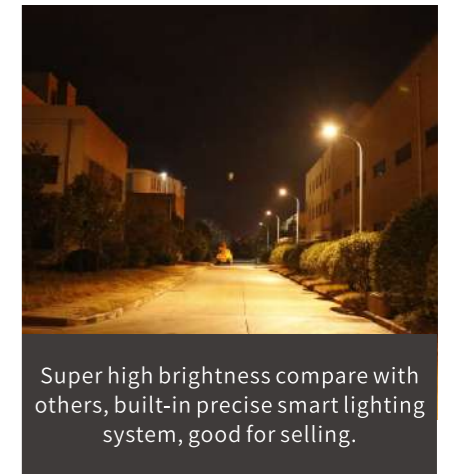

Super high brightness compare with others, built-in precise smart lighting system, good for selling.

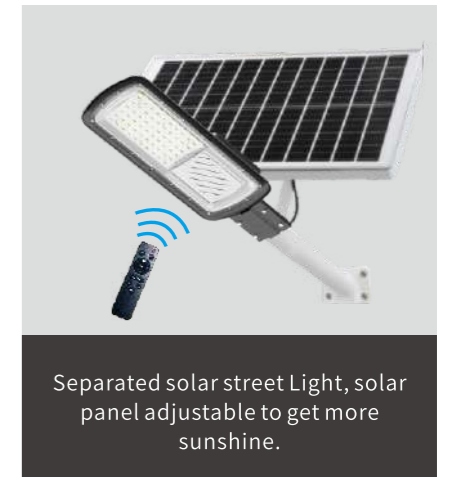

Separated solar street Light, solar panel adjustable to get more sunshine.



A variety of lenses are available

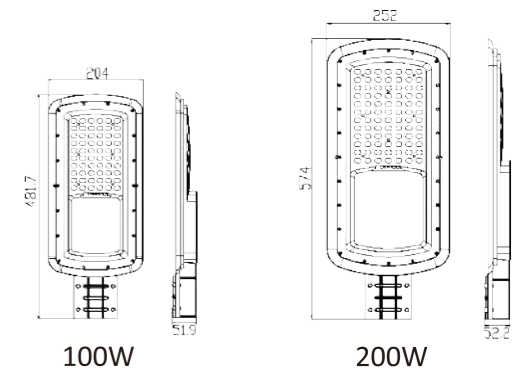

Model NO.	LED Source Power	Lumen	Solar Panel	Battery	Chips & QTY	Lamp Body Size	Solar Panel Size
EL-YYC-100	100W	1000lm	15W/6V	15AH	2835/60PCS	481*204*52mm	350*350mm
EL-YYC-200	200W	2200lm	24W/6V	20AH	2835/84PCS	574*252*52mm	350*450mm



# SEPARATED SOLAR STREET LIGHT

## EL-YH SERIES

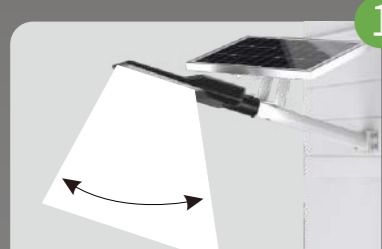
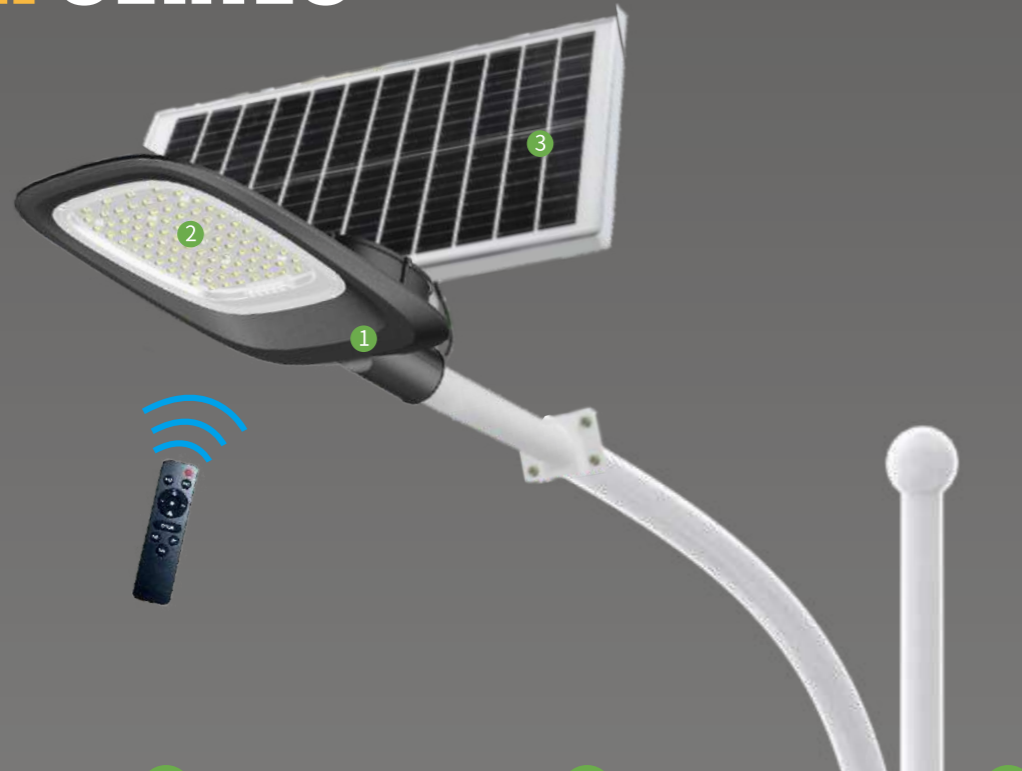

1  
Die-casting Aluminum Shell, ultra slim design  
120 degree beam angle

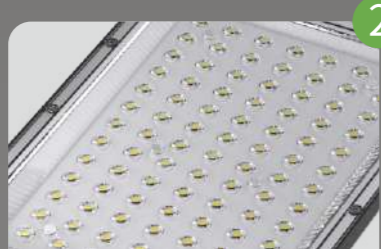

2  
Super high brightness,  
built-in precise smart lighting system



3  
High efficiency mono crystal solar panel,  
smaller size and save CBMs.

- Remote control and light control
- Charging time effective sunshine 4-6 hours
- Working hours last for 2 cloudy days

### SEPARATED SOLAR STREET LIGHT

Solar Panel Adjustable To Get More Sunshine

Material:Die-casting Aluminum+PC lens  
Auto Mode Max. Working Time:14H  
Charging Time:4-6H



**LiFePo4 battery**  
Large-capacity lithium iron phosphate battery, long life



Super high brightness compare with others, built-in precise smart lighting system, good for selling.



Separated solar street Light, solar panel adjustable to get more sunshine.

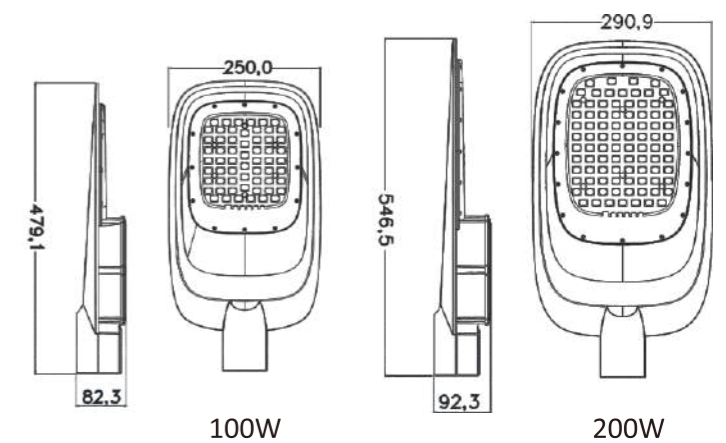

Model NO.	LED Source Power	Lumen	Solar Panel	Battery	Chips & QTY	Lamp Body Size	Solar Panel Size
EL-YH-100	100W	1000lm	15W/6V	15AH	2835/60PCS	479*250*82mm	390*430mm
EL-YH-200	200W	2200lm	24W/6V	20AH	2835/84PCS	545*290*92mm	390*560mm





# SOLAR GARDEN LIGHT EL-UFO SERIES



Highlight LEDs  
Bright & even output



High efficiency mono-crystal solar panel

 Lighting control PIR sensor remote control	 Charging time effective sunshine 4-6 hours	 Working hours last for 2 cloudy days
---	---	--

## EASY INSTALLATION

Unique Appearance Design,  
Private Mould, More Competitive.

Material:ABS+PC  
Auto Mode Max. Working Time:14H  
Charging Time:4-6H



**LiFePO4 battery**  
Large-capacity lithium iron phosphate battery, long life

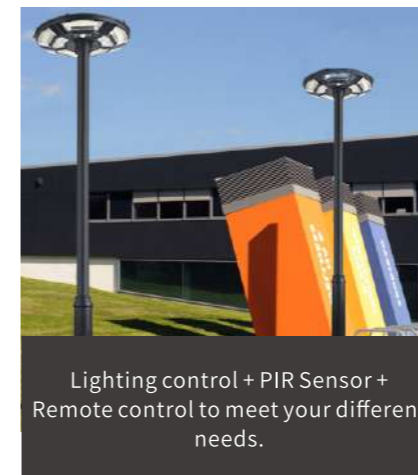
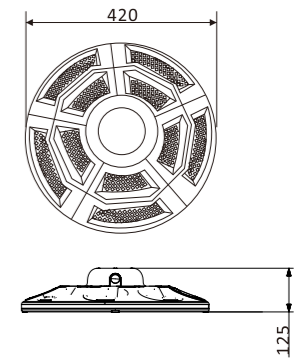

Lighting control + PIR Sensor + Remote control to meet your different needs.



Wall mounted installation for option



Certified 3.2V LiFePO4 battery, longer lifespan, no problem for shipping.

Model NO.	LED Source Power	Lumen	Solar Panel	Battery	Chips & QTY	Lamp Body Size	Solar Panel Size
EL-UFO-5	180W	1800lm	15W/6V	12AH	2835/375PCS	Φ420*125mm	Φ420mm
EL-UFO-9	180W	2400lm	18W/6V	15AH	2835/750PCS	Φ420*125mm	Φ420mm



# SOLAR GARDEN LIGHT

## EL-YX SERIES



Highlight LEDs  
Bright & even output



Aluminum alloy shell  
sturdy and durable

Remote control and light control	Charging time effective sunshine 4-6 hours	Working hours last for 2 cloudy days
----------------------------------	--	--------------------------------------

### EASY INSTALLATION

Unique Appearance Design,  
Private Mould, More Competitive.

Material:Die-casting Aluminum+PC lens  
Auto Mode Max. Working Time:14H  
Charging Time:4-6H



LiFePo4 battery  
Large-capacity lithium iron phosphate battery, long life

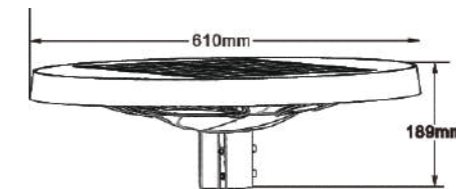

30W

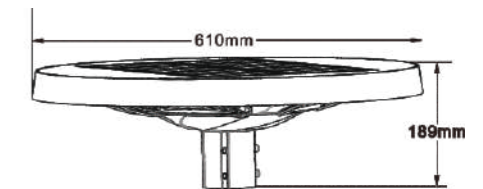

40W

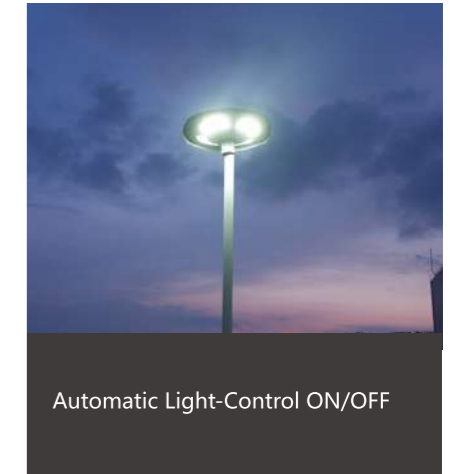

Automatic Light-Control ON/OFF



Lighting control + PIR Sensor + Remote control to meet your different needs.

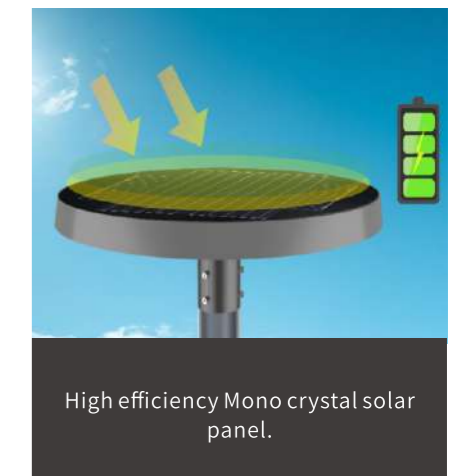

High efficiency Mono crystal solar panel.



Model NO.	LED Source Power	Lumen	Solar Panel	Battery	Chips & QTY	Lamp Body Size	Solar Panel Size
EL-YX-30	30W	800lm	25W/5V	25AH	3030/104PCS	F 610*189mm	F 610mm
EL-YX-40	40W	1000lm	35W/5V	35AH	3030/104PCS	F 610*189mm	F 610mm





# SOLAR GARDEN LIGHT EL-LX SERIES



 Lighting control PIR sensor remote control	 Charging time effective sunshine 4-6 hours	 Working hours last for 2 cloudy days
---	---	--

## EASY INSTALLATION

Unique Appearance Design,  
Private Mould, More Competitive.

Material:Die-casting Aluminum+PC lens  
Auto Mode Max. Working Time:14H  
Charging Time:4-6H



**LiFePo4 battery**  
Large-capacity lithium iron  
phosphate battery, long life

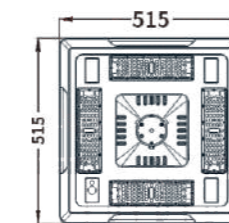

30W

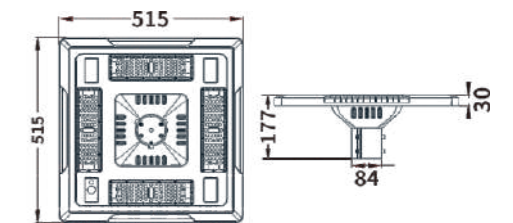

40W



Automatic Light-Control ON/OFF

Model NO.	LED Source Power	Lumen	Solar Panel	Battery	Chips & QTY	Lamp Body Size	Solar Panel Size
EL-LX-30	30W	800lm	25W/5V	25AH	3030/256PCS	515*515*177mm	500*500mm
EL-LX-40	40W	1000lm	35W/5V	35AH	3030/256PCS	515*515*177mm	500*500mm



# SOLAR WALL LIGHT EL-SWL SERIES



Lithium Battery  
Replaceable



High efficient  
mono crystalline  
silicon solar panel



Unique dural-light  
design for decoration  
and illumination

<p>Lighting control PIR sensor control</p>	<p>Charging time effective sunshine 4-6 hours</p>	<p>Working hours last for 2 cloudy days</p>
--	---	---

## 2 MODES TO MEET DIFFERENT NEEDS

Perfect for each season, no quiet selling time.  
Multi-funtion, suitable for different customer's demand.  
Ultimate visual experience: Much brighter, more comfortable.

Material:ABS+PC  
Auto Mode Max.Working Time:14H  
Charging Time:4-6H

MODE A

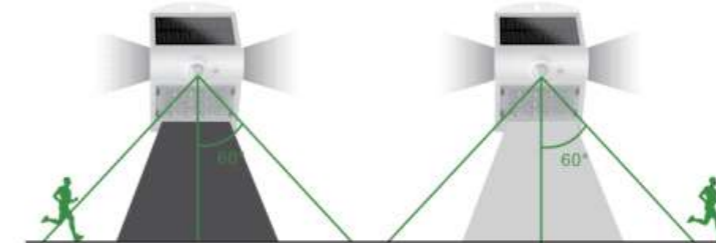

MODE B

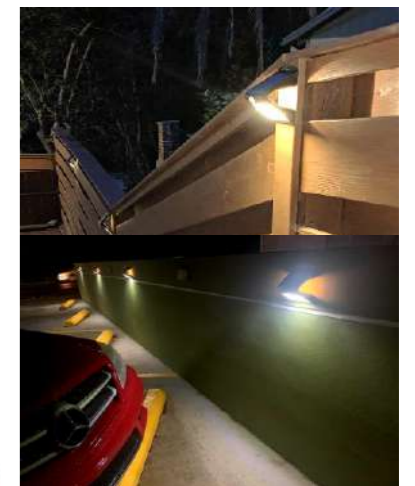
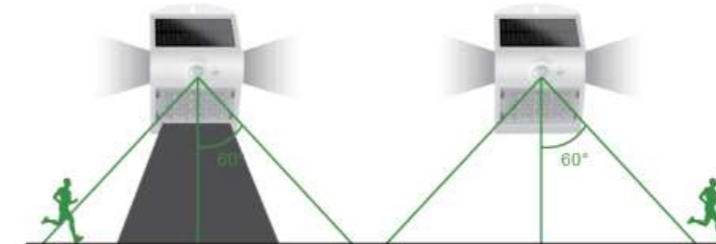

Model No.: EL-SWL-1.5W



Lumen: 220lm  
Output Power: 1.5W  
Li-ion Battery: 3.7V \*1200mAh  
Mono Solar Panel: 0.7W  
Housing Material: ABS+PC,  
Beam Angle: 90°  
Detection Angle/Distance: 120° /6M  
IP Rate: Ip65  
Housing Color: Black /White  
Lamp Size: 152\*96\*84mm

Model No.: EL-SWL-4W



Lumen: 500lm  
Output Power: 4W  
Li-ion Battery: 3.7V, 2000mAh  
Mono Solar Panel: 2.4W  
Housing Material: ABS+PC  
Beam Angle: 90°  
Detection Angle/Distance: 120° /6M  
IP Rate: Ip65  
Housing Color: Black /White  
Lamp Size: 211\*140\*115mm





# SOLAR WALLLIGHT EL-SXQ SERIES

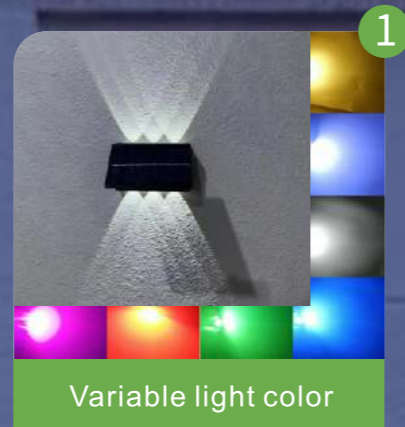

- Lighting control  
PIR sensor control
- Charging time  
effective sunshine  
4-6 hours
- Working hours  
last for 2 cloudy days

## MULTIPLE UNIQUE LIGHT SHADOW

makes the courtyard full of artistic ambience.  
Perfect decoration for villas, parks, neighborhoods, porches,  
terraces, corridors, gardens, etc.



Model No.: EL-SXQ-4

Solar Panel: 1.3W  
Battery: 1200mAh  
Brightness: 300LM /20LM  
CCT: 3000K-6500K or Colorful  
LED: SMD2835  
Material: Plastic  
WaterProof: Ip65  
Size: 132\*123\*43mm



Model No.: EL-SWQ-5

Solar Panel: 1.8W  
Battery: 1800mAh  
Brightness: 500LM /20LM  
CCT: 3000K-6500K or Colorful  
LED: SMD2835  
Material: Plastic  
WaterProof: Ip65  
Size: 158\*123\*43mm



Model No.: EL-SWQ-6

Solar Panel: 2W  
Battery: 1800mAh  
Brightness: 840LM /20LM  
CCT: 3000K-6500K or Colorful  
LED: SMD3030/5050  
Material: Plastic  
WaterProof: Ip65  
Size: 155\*100\*85mm



Model No.: EL-SWQ-7

Solar Panel: 3W  
Battery: 1800mAh  
Brightness: 840LM /20LM  
CCT: 3000K-6500K or Colorful  
LED: SMD3030/5050  
Material: Plastic  
WaterProof: Ip65  
Size: 160\*160\*40mm





# SOLAR Rotatable WALL LIGHT EL-EWF SERIES



Rotatable



human body induction



High efficiency mono solar panel

Lighting control PIR sensor control	Charging time effective sunshine 4-6 hours	Working hours last for 2 cloudy days
--	--	---

### 3 MODES TO MEET DIFFERENT NEEDS

- Dim constant light all night long
- Dim/strong light with human body induction
- On/off full light with human body induction

Material:ABS+PC  
Auto Mode Max.Working Time:14H  
Charging Time:4-6H



EL-EWF301



EL-EWF302



EL-EWF303



Model NO.	Color & Control	Lumen	Solar Panel	Battery	Chips & QTY	Lamp Body Size	Solar Panel Size
EL-EWF301-5W	2700 - 6500K PIR+Switch	500lm	1.8W/5V	2400mAH	2835/100PCS	285*80*45mm	150*100*40mm
EL-EWF302-7W	2700 - 6500K PIR+Switch	700lm	1.8W/5V	3600mAH	2835/198PCS	350*100*45mm	150*100*40mm
EL-EWF303-10W	2700 - 6500K PIR+Switch	1000lm	3.5W/5V	4400mAH	2835/198PCS	350*100*45mm	150*200*40mm





# SOLAR LED STRIP EL-DD SERIES

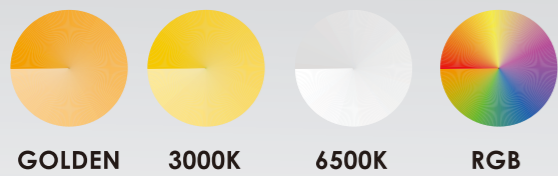
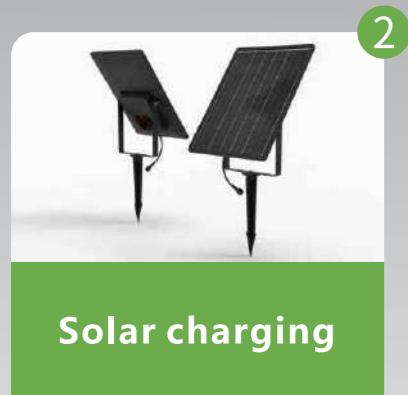
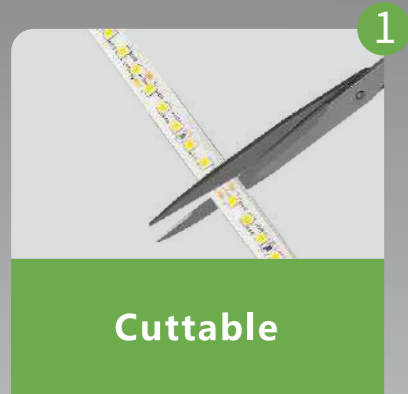

**New Battery**

- Remote control and light control
- Charging time effective sunshine 4-6 hours
- Working hours last for 2 cloudy days

**UNIQUE APPEARANCE DESIGN**  
Private Mould, More Competitive.

- Material:PVC
- Working Time:>12H
- Charging Time:4-6H

**Multiple Working Modes**

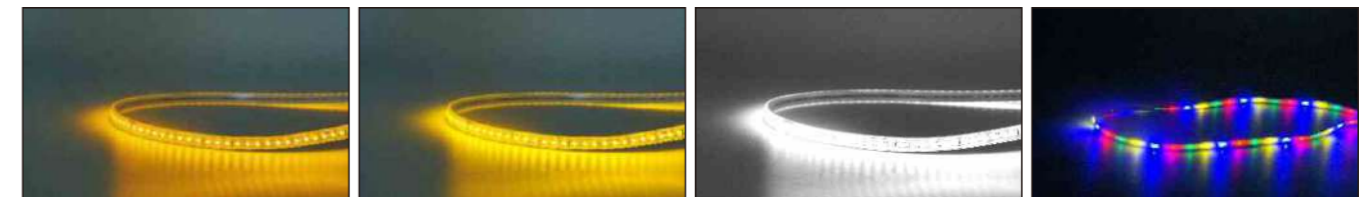
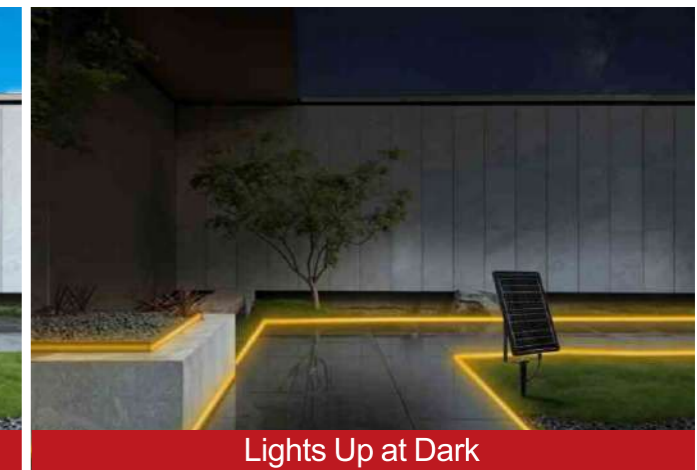
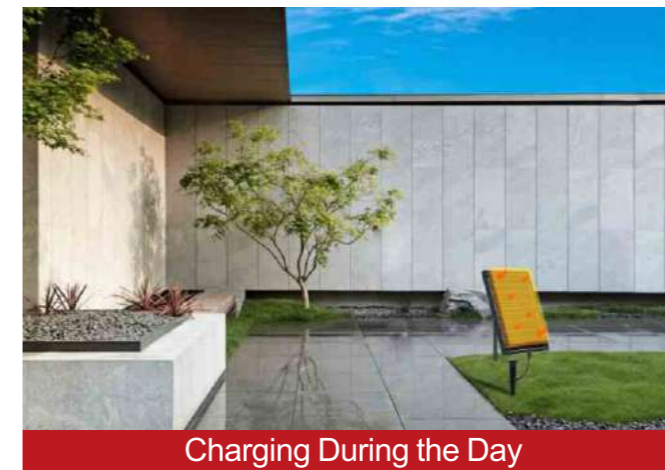

Item No.	Length	Lithium Battry	Solar Panel	Solar Panel Size(mm)	LED Chip
EL-DD-5M	5M LED strip+2m cable	1.2AH/3.7V	1.2W/5V	100*80	SMD2835/300PCS
EL-DD-10M	10M LED strip+2m cable	1.8AH/3.7V	1.8W/5V	135*80	SMD2835/600PCS
EL-DD-20M	20M LED strip+5m cable	2.4AH/3.7V	2.5W/5V	135*160	SMD2835/1280PCS
EL-DD-25M	25M LED strip+5m cable	2.4AH/3.7V	2.5W/5V	135*160	SMD2835/1600PCS



# SOLAR POST CAP LIGHT

## EL-QW SERIES

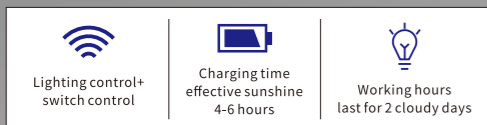

### EASY INSTALLATION

Private Mould, More Competitive.  
Unique Appearance Design,

Material:ABS  
Auto Mode Max.Working Time:12H  
Charging Time:4-6H

#### PRODUCT FEATURES

- Unique appearance design, Private Mould, more competitive.
- Lighting Control: Light OFF and charging on daytime, Light ON at night.
- Certified 3.2V LiFePO4 battery, longer lifespan, no problem for shipping.

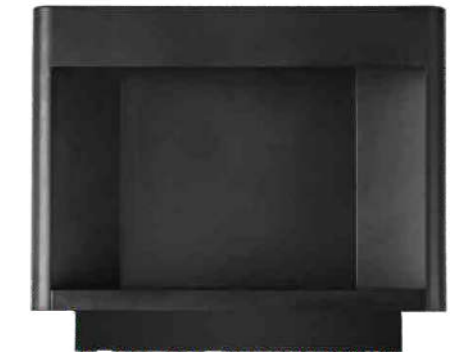
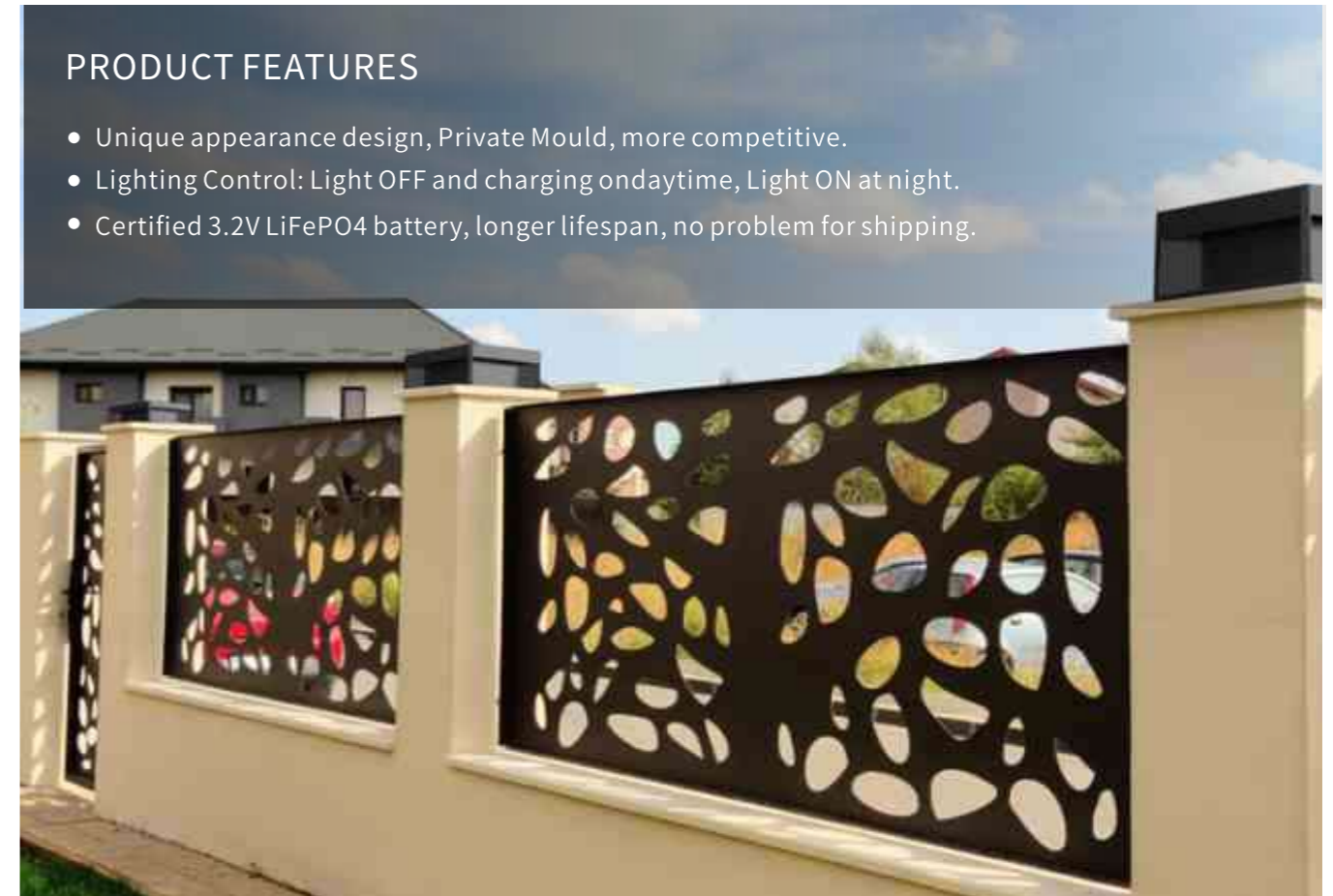

Model NO.	Material	Solar Panel	Battery	Chips & QTY	Power Cord	Lamp Body Size	Solar Panel Size
EL-QW-S150	ABS	5V/1.6W	3.2V/1.2AH	3030/32PCS (2 CCT 3000K/6500K)	/	150*150*125mm	140*140*4mm





# SOLAR POST/LAWN LIGHT

## EL-ZTD SERIES

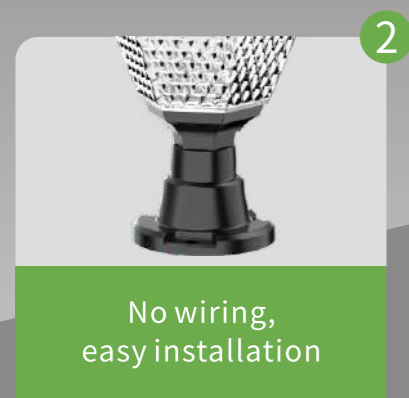
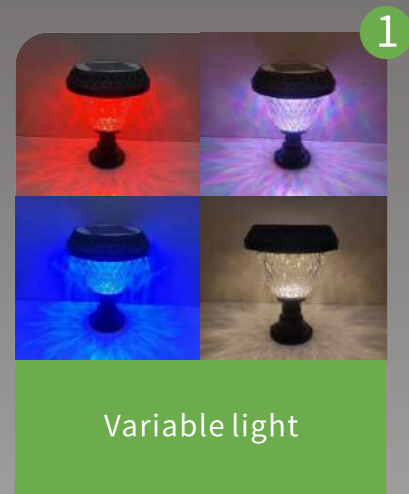

Lighting control+ switch control	Charging time effective sunshine 4-6 hours	Working hours last for 2 cloudy days
----------------------------------	--	--------------------------------------

### MULTIPLE INSTALLATION METHODS

Grounding Installation, Wall Installation, Base Installation Column Installation

Material:ABS+PC  
Max. Working Time:12H  
Charging Time:4-6H

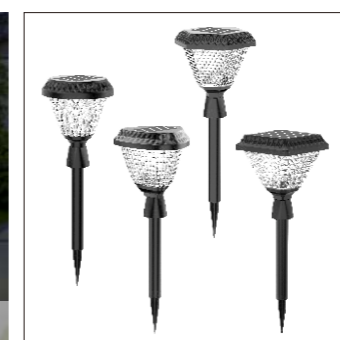
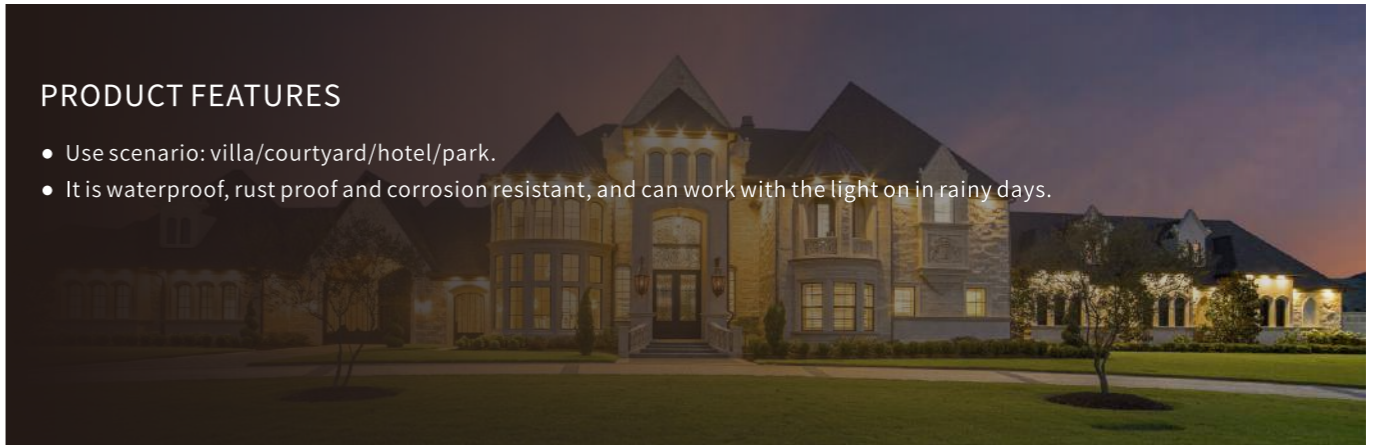

Product name	Circular	Triangle	Hexagon	Square
Column head type:	Φ160*H213mm	Φ173*167*H213mm	Φ185*160*H209mm	Φ160*160*H213mm
Wall mounted:	Φ160*225*H118mm	Φ173*232*H188mm	Φ185*225*H183mm	Φ160*225*H188mm
Ground plug type:	Φ160*H690mm	Φ173*H690mm	Φ185*H690mm	Φ160*H690mm
Central column type:	Φ160*H667mm	Φ173*H667mm	Φ185*H667mm	Φ160*H667mm
PV panel size:	Φ121mm	128*128 Circular triangle	Hexagon side length 69.5mm	121*121mm
PV panel power:	5V 1.1W	5V 1.2W	5V 1.3W	5V 1.8W



Material:ABS+Lens  
 Max. Working Time:12H  
 Charging Time:4-6H

PRODUCT FEATURES

- Unique appearance design, Private Mould, more competitive.
- Lighting Control: Light OFF and charging on daytime, Light ON at night.
- Certified 3.2V LiFePO4 battery, longer lifespan, no problem for shipping.

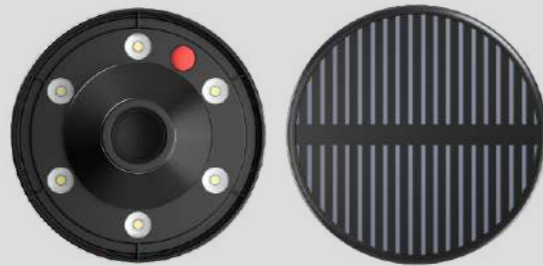
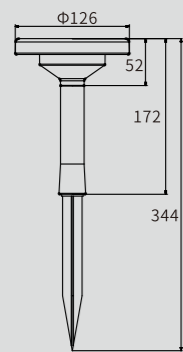

Model NO.	Color	Lumen	Solar Panel	Battery	Chips & QTY	Lamp Body Size	Solar Panel Size
EL-FY-WW	6500K	/	1.1W/5V	1200mAH	3030/6PCS	Φ126*51.8mm	Φ115*2mm
EL-FY-CW	3000K	/	1.1W/5V	1200mAH	3030/6PCS	Φ126*51.8mm	Φ115*2mm
EL-FY-RGB	RGB/1 color Switchable	/	1.1W/5V	1200mAH	3030 6PCS/RGB	Φ126*51.8mm	Φ115*2mm



Material:ABS+Lens  
 Max. Working Time:12H  
 Charging Time:4-6H

PRODUCT FEATURES

- Three working modes are changeable: High-light, semi-light, breathing.
- Mono crystal solar panel.
- Certified 3.7V LiFePO4 battery, longer lifespan, no problem for shipping.

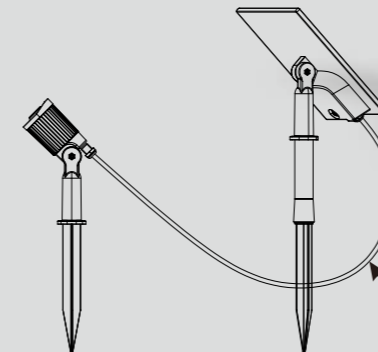

Standard cable 3 meters

Model NO.	Lumen	Solar Panel	Battery	Chips & QTY	Number of lamp caps	Lamp Body Size	Solar Panel Size
EL-CPD-LY04	90lm	5.0V/5W	3.7V/4000mAH (Brand New)	3030 4PCS	4 heads	Φ53.3*369.3mm	Φ204*167mm
EL-CPD-LY06	90lm	5.0V/5W	3.7V/4800mAH (Brand New)	3030 6PCS	6 heads	Φ53.3*369.3mm	Φ204*167mm

